

Evolve SLS Rear Seat Entertainment System

Owner's manual

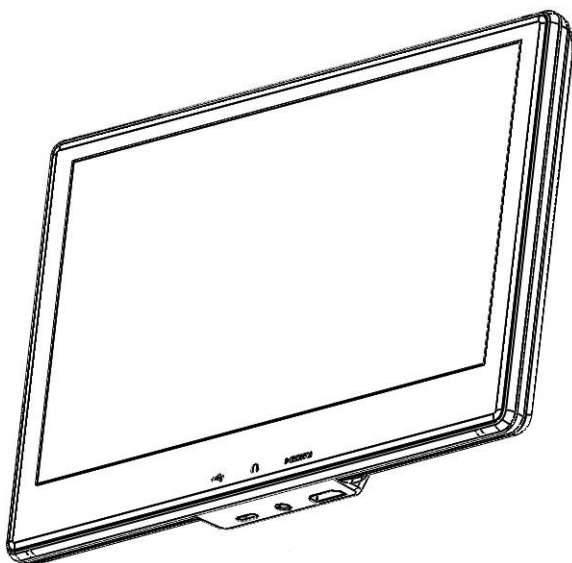

EVOLVE SLS REAR SEAT ENTERTAINMENT SYSTEM

SYSTEM SET-UP	4
POWER UP	4
INITIAL SETUP	4
WATCHING CONTENT	8
Log In to Screenhits TV	8
Important Notice	9
Safety Precaution	9
Product Features	9
Warnings	9
Caution	9
Bluetooth Headphones	11
How Pair and Use the Bluetooth Headphones	11
Installing or Replacing the Battery	12
Remote Control Operation (continued)	13
General Operating Instructions	14
Turning the monitor ON or OFF	14
Navigation Bar	16
Settings	16
Language	16
Monitor Pairing	17
Volume	16
Brightness	16
Wi-Fi Internet Connection	18
Bluetooth	19
Software	19
Tutorial	19
Read Back	20
User Manual	20
Restart	20
Factory Reset	20
Streaming	21
Gaming	22
Live TV	22
Profiles	22
Parental Controls	22
Streaming Search	23
Services	23
HDMI	26
Compliance Information	27
FCC Warning:	27
ITE Notice:	28

© 2024 Voxx International Corporation. All rights reserved. This manual, or any portion thereof, may not be reproduced without the express written permission of Voxx International Corporation. Design and specifications are subject to change without notice.

SYSTEM SET-UP

POWER UP

Turn vehicle's ignition key to the 'run' position, the EVOLVE SLS Rear Seat Entertainment (RSE) system will automatically start to power up.

Note: Once the screen has powered up, it will automatically go to sleep after 30 seconds of non-use. The screen can be put to 'sleep' by pressing the 'power' button on a paired remote control, or by using the on-screen power button (see page).

INITIAL SETUP

Upon initial power-up of your RSE system, the following steps will be performed on both monitors before the system can be fully used. The RSE system will walk you through this process step by step.

1) Select a Language

- a) Welcome! select your preferred language from the list. Then press the **Next** button to continue the setup of your RSE system.

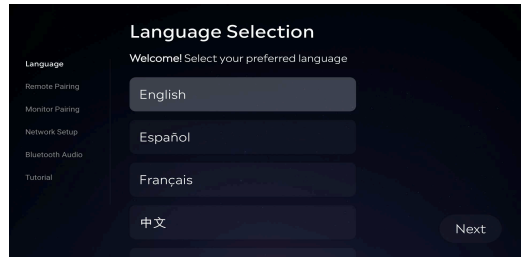

2) Pair a Remote Control

- a) Follow screen information and press **Next** then press and hold the Vol- and Vol+ buttons simultaneously for 3 seconds until the red LED light on the top of the remote starts blinking.
- b) The RSE is now searching for the remote signal.

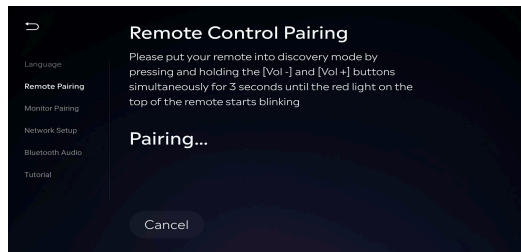
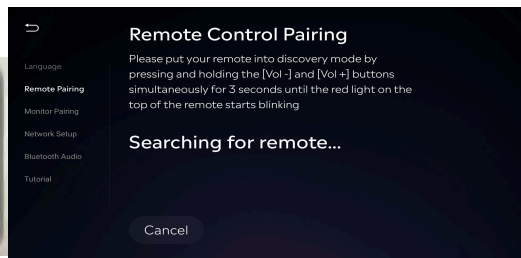

- c) Once the remote is paired the screen will confirm that it is connected. Continue by selecting the **Next** button.

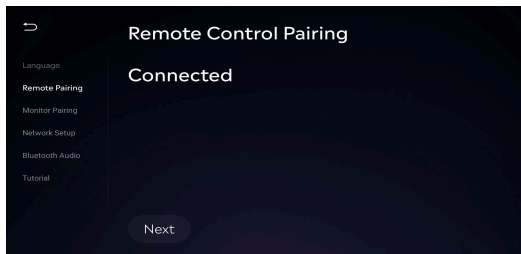

INITIAL SETUP- Cont.

3) Monitor Pairing

- a) The RSE system will automatically start searching for and pairing with the second RSE Monitor.

- b) Once the second RSE Monitor is found, it will start connecting.

- c) Once connected, setup is complete. This allows both monitors to view the same source. Continue by selecting the **Next** button.

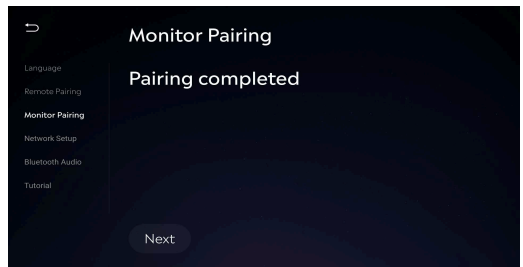
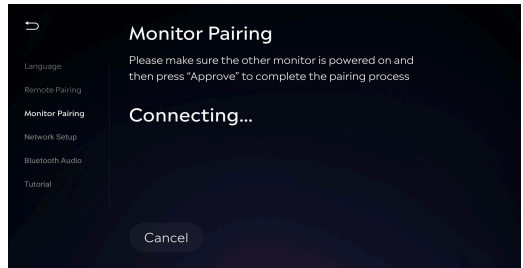
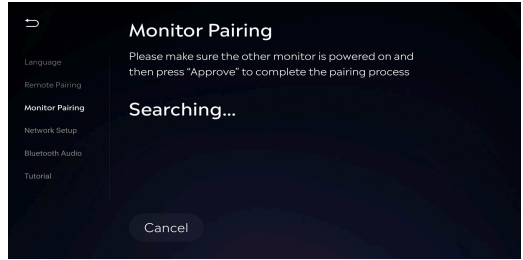

INITIAL SETUP - Cont.

4) Internet Connection

a) An Internet connection is required for some features of the RSE system to work. Select a network that appears on the screen that works best for you.

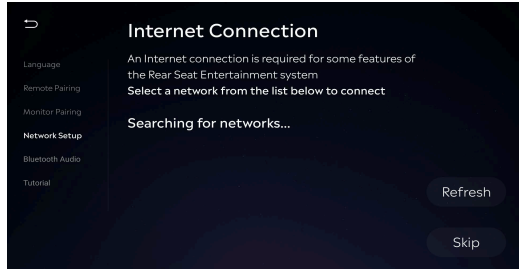

b) Once selected, you will be asked to enter the connection password. use the keyboard to enter the password.

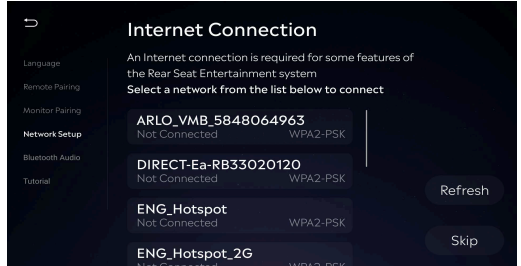

c) The RSE system will connect to the Internet. Selecting the connection, you can also view the status or disconnect from that connection. Select the **Next** button to continue.

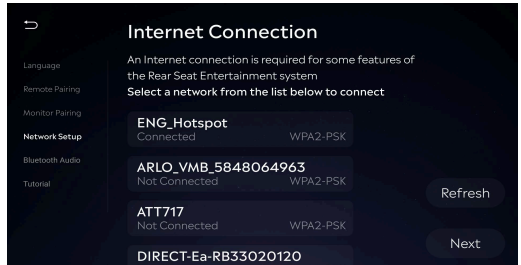
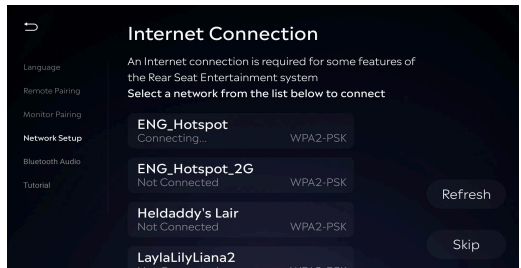
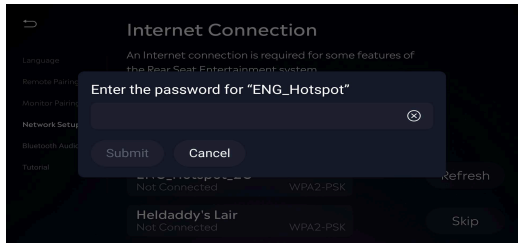

INITIAL SETUP - Cont.

4) Bluetooth Audio Pairing

- a) Connect a Bluetooth audio device (like headphones and/or the vehicle radio) to listen to the audio from this display through the device. Put your Bluetooth device in pairing mode and select it from the list.
- b) Once the device is selected, paired and connected select the **Next** button to proceed.



4) Tutorial

- a) This tutorial will walk you through the functionality and Navigation of the system. Press **Next** button to begin the Tutorial or press **Skip** to ignore the step. The Tutorial can be accessed later from Settings under "More Settings>Tutorial". All steps will also be explained in the Owner's Manual starting page.

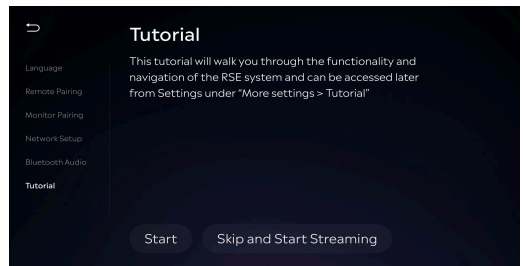

WATCHING CONTENT

Log In to Screenhits TV

Welcome to Screenhits TV. Find all your streaming in one place. ScreenHits TV brings together all your favorite streamers into a unique TV Guide, making finding something to watch easier with exclusive features. Enjoy a free 3-year subscription.

NOTE: You must be connected to Wi-Fi with an active Internet connection to stream content.

1) Scan QR code

- a) Scan QR code with a phone or tablet. Select the Register button and enter information needed. once complete return to RSE Monitor.

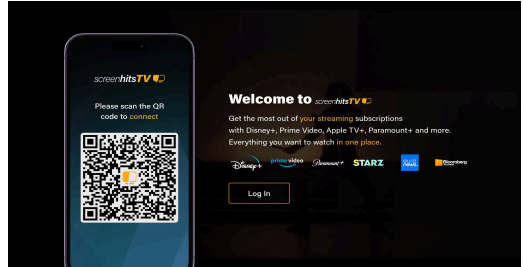

- b) Log into Screenhits TV with your new credentials.

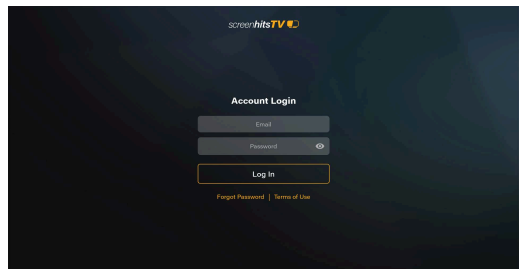

- c) Discover and enjoy all that Screenhits TV has to offer.

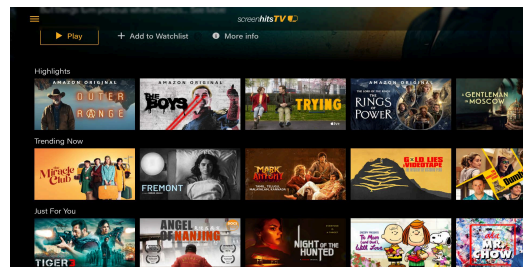
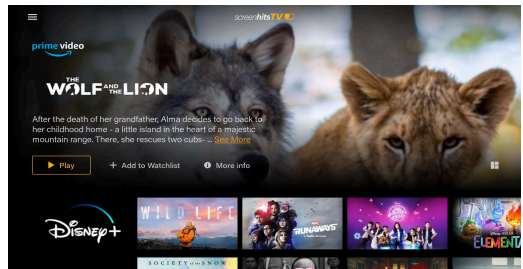

Welcome to EVOLVE SLS Rear Seat Entertainment

Thank you for purchasing the Rear Seat Entertainment System with Screenhits TV. Before operating the system, read this manual thoroughly and retain it for future reference. The Manual is always available by scanning the code on page 20.

Important Notice

It is unlawful in most jurisdictions for a person to drive a motor vehicle which is equipped with a television viewer or screen that is in the motor vehicle at any point forward of the back of the driver's seat, or that is visible, directly or indirectly, to the driver while operating the vehicle. The monitors should never be installed where they will be visible directly, or indirectly, by the operator of the motor vehicle.

Safety Precaution

For safety reasons, do not allow children to unfasten safety belts to make any adjustments to the system. System adjustments can be accomplished using the remote-control unit, while safety belts remain fastened. Enjoy your entertainment system but remember that the safety of all passengers remains the number one priority. Direct eye contact from protruding HDMI cables and or USB memory sticks may result in injury during an accident. To prevent eye injury, disconnect all HDMI cables and USB memory sticks when not in use.

Product Features:

Evolve SLS

- 10-inch Color Touch Screen Panel (1024x600) with 16:9 aspect ratio
- 16GB on board Memory
- USB Type C, and HDMI Ports
- 3.5mm Stereo Headphone Output
- Android Operating System
- Bluetooth Remote Control
- Bluetooth Wireless Headphones
- Wi-Fi Connectivity
- Monitor screen duplication
- Media Streaming
- Over The Air (OTA) System updates

Warnings

- Do not use any harsh solvents or chemicals when cleaning the unit.
- Do not use any abrasive cleaners that may scratch the screen. Use only a lightly dampened lint free cloth to wipe the screen if it is dirty.
- Do not put pressure on the screen.

Caution

Be sure to run the vehicle engine while using the system. Using this system without running the engine can result in battery drain. To avoid the risk of battery drain, please remember to turn off the system when the vehicle is not in use. Do not touch the inner pins of the jacks on the front panel. Electrostatic discharge may cause permanent damage to the system.

Front Panel - EVOLVE SLS

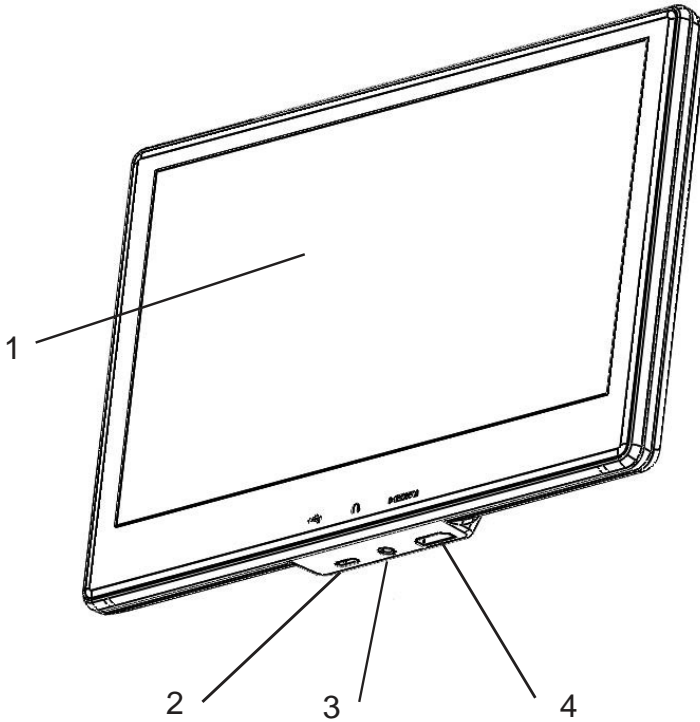

- 1) **10-inch Touch Screen Panel.**
- 2) **USB Type C Port.** You can play music, images, and videos stored on most USB devices.
- 3) **Headphone Output Jack.** Connect wired headphones using a 3.5 mm stereo connector.
- 4) **HDMI Port.** Connect an external audio/video source using a MHL or HDMI connector.

Bluetooth Headphones

Each monitor includes a built in Bluetooth transmitter for the use with Bluetooth Headphones and other devices. Each Headphone must be paired with a separate monitor.

How Pair and Use the Bluetooth Headphones

- 1) Once initial set-up of the monitor is complete, using a remote or on-screen touch select the settings button.
- 2) Select the "Connectivity settings".
- 3) Select "Bluetooth settings".
- 4) On your Bluetooth headphones, press and hold the power button for 3 seconds. Indicator LED will flash Blue, it is now in pairing mode. (Blue Flashing LED)
- 5) The Monitor will discover either VOXXBT18 or VOXXBT19. Select the Headphone VOXXBT that is present.

- 6) Your Headphone is now paired and ready to use. You can now pair the other headphones to the other monitor.

Other features of your Bluetooth Headphones:

Rechargeable battery with Micro USB/USB C charging cable.

Headphones cannot be used while charging.

Use 3.5 wired cable for direct connection to monitor if batteries die.



- 1) Volume up+
- 2) Power
- 3) Volume Down-
- 4) Indicator LED
- 5) Micro USB Charging, DC IN Port
- 6) 3.5 Stereo Line IN Port

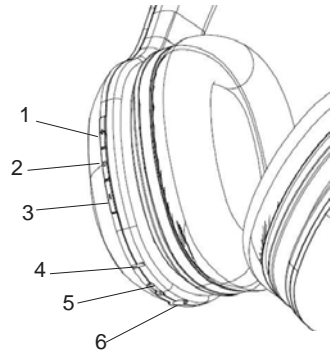

Wired Headphones (not supplied)

This RSE System will allow you to use your personal headphones to listen to audio content. There are 3.5mm stereo headphone output jacks located below the front panel of each monitor which can be used with most standard stereo headphones. Bluetooth and Wired headphones cannot be used at the same time on the same monitor.

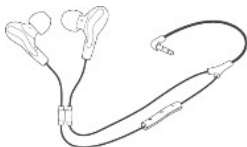

Remote Control Operation

Installing or Replacing the Battery

1) On the rear of the remote, slide the cover down.

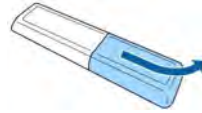

2) Remove cover, once cover is removed remove old batteries if needed.



3) Install two “triple AAA” batteries as shown. Make sure that proper polarity (+ or -) is observed. replace the cover back on and slide upward.



NOTE: This remote control is only designed to operate this device. It is not a universal remote control and will not operate any other device.

Warning/Caution on using batteries.

- Always ensure that the battery is inserted with the positive and negative terminals in the correct direction as shown in the battery compartment.
- If the remote control fails to function, replace the battery before seeking repairs at the dealer.
- Keep batteries out of the reach of children. Should the battery be swallowed, immediately consult a doctor. When disposing of used batteries, please comply with governmental regulations or environmental public institution rules that apply in your country/area.
- Remove the battery if the remote control is not used for a month or longer to avoid corrosion and damage to the remote control.

Remote Control Operation (continued)

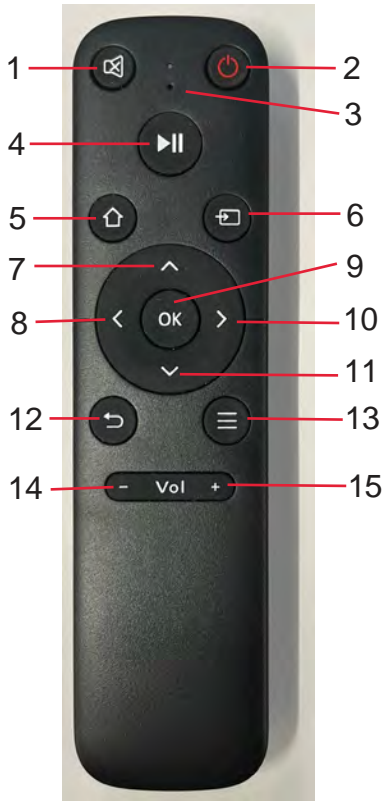

1. **Mute** - Press to Mute volume.
2. **Power** - Press to power the monitor ON or switch to OFF/Standby mode.
3. **Indicator LED Light** - flashes during Pairing.
4. **Play/Pause** - Play or Pause video and music playback (for supported content).
5. **Home** - Return to Home screen.
6. **Input Toggle**- choose streaming, HDMI, or USB inputs.
7. **Directional Navigation Up** - Press directional keypad to scroll up.
8. **Directional Navigation Left** - Press directional keypad to scroll left. Press and Hold for Fast Rewind.
9. **Select** - Press to select the item or option currently highlighted on-screen.
10. **Directional Navigation Right** - Press directional keypad to scroll right. Press and Hold for Fast Forward.
11. **Directional Navigation Down** - Press directional keypad to scroll down.
12. **Back** - Return to the previous screen or action.
13. **Menu** - Open more options, based on the item or function currently selected on-screen.
14. **Volume (-)** - Adjust your monitor volume lower.
15. **Volume (+)** - Adjust your monitor volume higher.

General Operating Instructions

Turning the monitor ON or OFF

When the vehicle is turned to ON or to ACC the monitors will automatically boot-up to Screenhits TV profile page (after initial setup). The POWER button on the remote or the on-screen Navigation Bar when pressed will put the monitor into Sleep/Stand-by mode. Once the POWER button is pressed again or tap the screen, the screen will wake up in Profile mode. Once the monitor has been turned on and is displaying a picture, you can optimize the picture quality by pivoting the screen forward or backward to adjust the viewing angle.

NOTE: It is recommended to put the monitor into Sleep/Stand-by mode when not in use.

Navigation Bar



Anytime the screen is touched at top edge and pulled down or the Input button from the remote a drop-down Navigation Bar will appear. The Navigation bar allows the user to access Power/Standby, Back, Home, Streaming/HDMI/USB, Monitor 1/2, and Settings.

Power

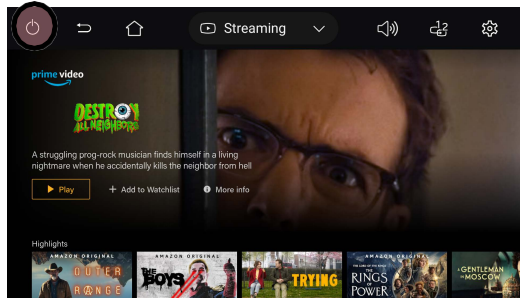
The Power button  can always be found in the top left corner of the Navigation Bar. Pressing the power button will turn off this display. The display can be turned on again by tapping the screen or using the button on the remote.



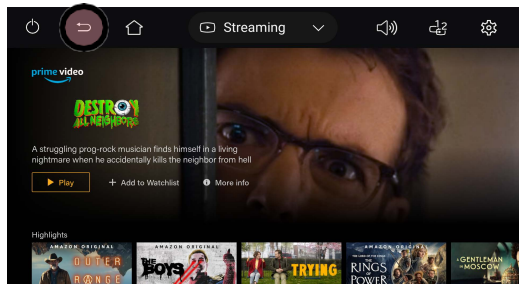

Back

The Back button  can be found next to the Power button. Pressing the back button will return to the previous screen. There is also a back button on the remote labeled .



Home

The Home button  can be found next to the back button. Pressing the home button will return to the Home page - Screenhits TV. There is also a back button on the remote labeled .

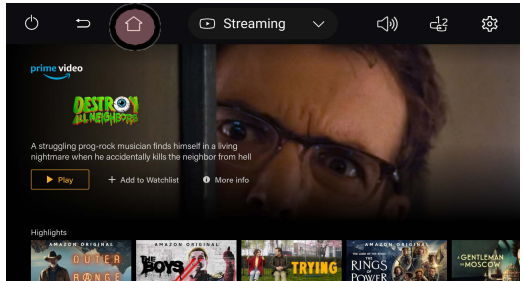

General Operating Instructions - Navigation Bar

Source Selector

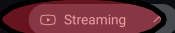
The Source Selector is located at the center of the Navigation Bar. This allows for switching between streaming, HDMI, and USB sources. To change the source, tap the source selector and select a source from the list. Using the remote, press the  button multiple times to toggle through the available sources.

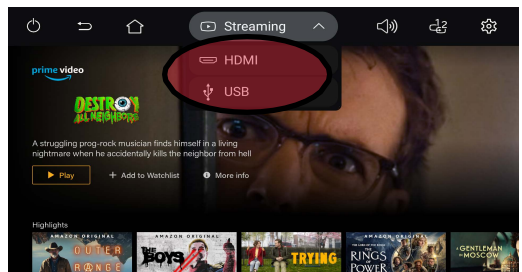
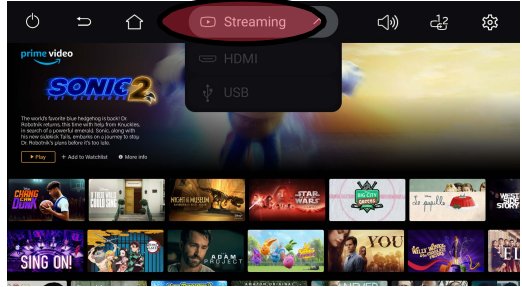

Duplicate

The Duplicate button is on the right side of the Navigation Bar. Duplicate a mirror of the second RSE screen in the vehicle to this screen. This is useful if you would like the same content to be watched on both screens. Tap the Duplicate button  to begin mirroring. You can also access using the remote control by pressing then navigating to and selecting the icon.

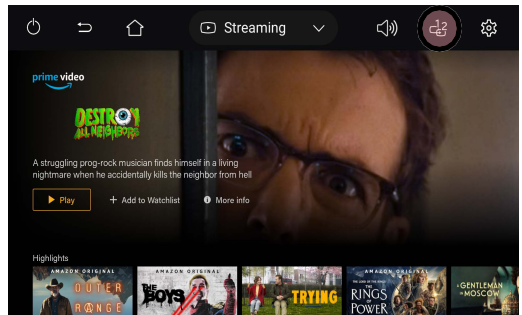

Settings

The Settings button is also located on the right side of the Navigation Bar. Here you can configure things like connectivity, parental controls, software updates and more. Tap the Settings button to enter the settings menu. You can also access using the remote control by pressing  to Navigate the settings.

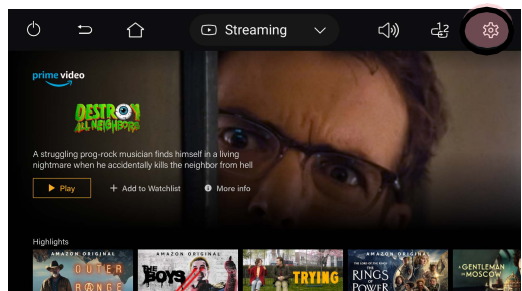

General Operating - Settings

Settings

In Settings you can access General settings, Connectivity settings, Software updates, and more. Select different categories within settings and make changes that suit the user. The following information is about the changes that can be made in settings.

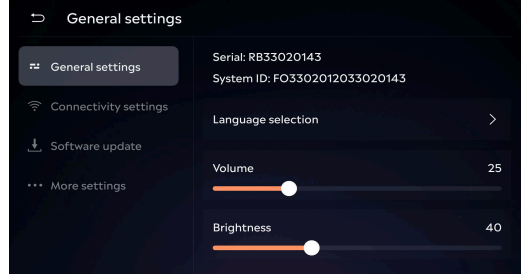

Language

During the initial setup process, you were able to pick a language that you would like to appear on your Monitor, you can change the language at any time. Select Settings, select Language selection, then scroll down until you find the Language you would like to see on your monitor.

NOTE: Some languages do not translate some words and symbols, in those cases they will show as in English.

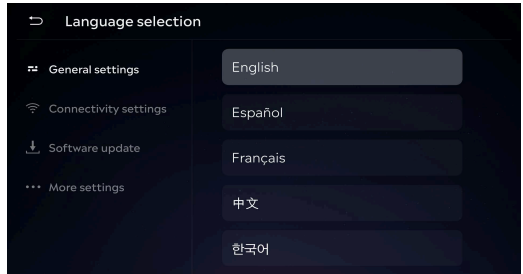

Volume

Volume can be controlled directly by touching the Volume bar and moving left or right. This will adjust the volume to be louder or quieter.

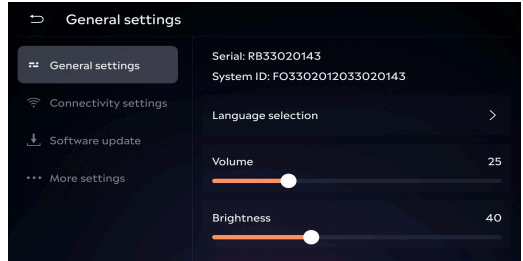

Brightness

Brightness can directly be controlled by touching the Brightness bar and moving left or right. This will adjust the volume brighter or dim.

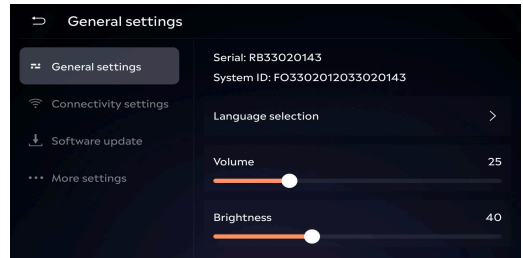

General Operating - Settings

Monitor Pairing

Select monitor pairing to pair and watch what is playing on the second monitor. When selected the system will search for another RSE monitor, once found the monitor will duplicate the image for shared viewing.

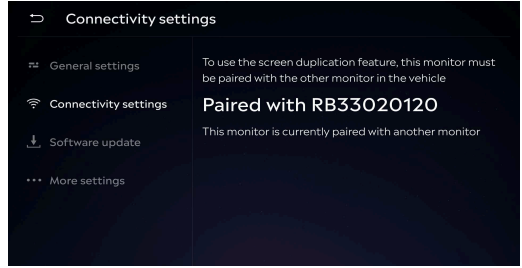

General Operating - Settings

Wi-Fi Internet Connection

Selecting Connectivity settings, then select Wi-fi settings, the system will scan for available Wi-fi connections or Hot spots and give you the best options. Select the best Wi-fi option. Once the keyboard appears, enter the password needed and submit. The RSE system will then connect to that wi-fi. When complete you can highlight the selected Wi-Fi connection and see status, disconnect, forget, or cancel.

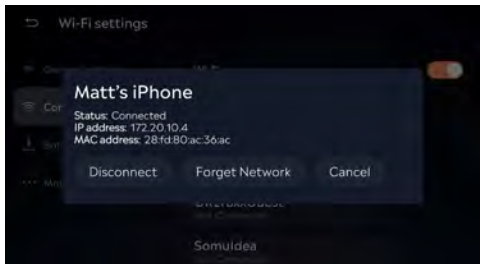
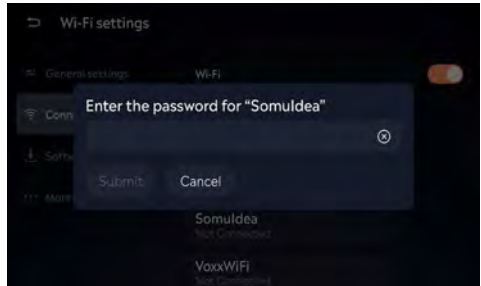

General Operating - Settings

Bluetooth

Selecting Bluetooth settings opens the ability to access Remotes, Game Controllers, and other Bluetooth Devices. Select Bluetooth settings, once selected the system searches for available Bluetooth devices. Select and pair with your choice of Bluetooth device. You can also pair with the vehicles Bluetooth and play audio through the vehicles speaker system.

NOTE: make sure all devices are in their pairing mode.

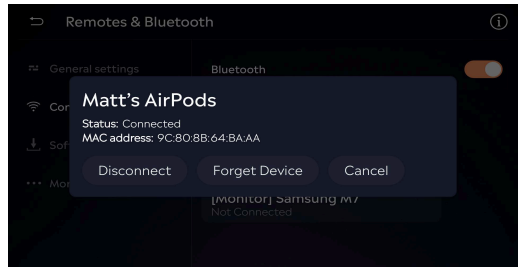

Software

Select Software update, the current Software version will show to the right. Select update if a new update is available the system will begin downloading the new version. You can leave that page and it will download in the background. The update will complete the next time you turn on the system. **NOTE: Make sure you have a good Wi-fi connection during the download.**

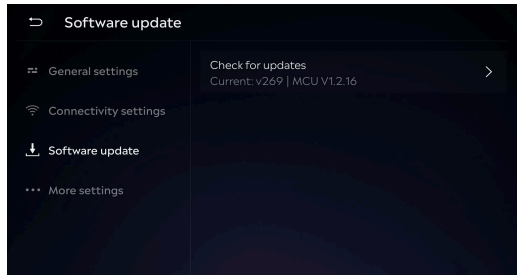

Tutorial

This tutorial will walk you through the functionality and Navigation of the system. Press Next button to begin the Tutorial or press Skip to ignore the step.

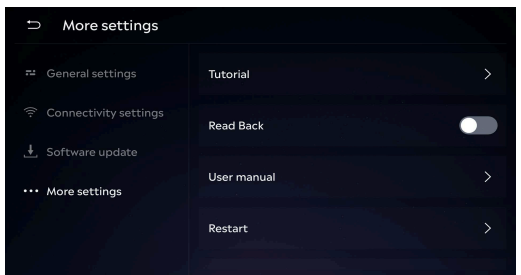

General Operating - Settings

Read Back

Read back is an accessibility feature which helps blind and visually impaired users interact with the system. When enabled, single-pressing or highlighting any item within the interface will readback the text description for that item through the system's audio output. Double pressing or selecting the item using "OK" on the remote will confirm the selection. Read Back can be toggled on or off by pressing and holding the Pause button on the remote for 10 seconds.

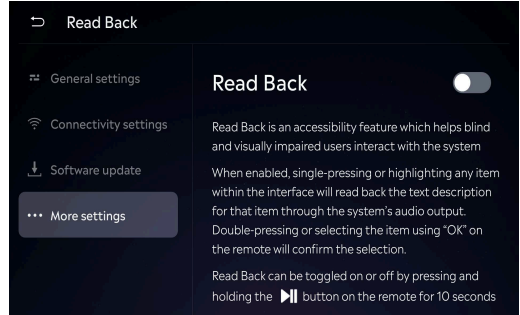

User Manual

Scanning the QR code will lead you to the most up to date owner's manual and copies in other languages.

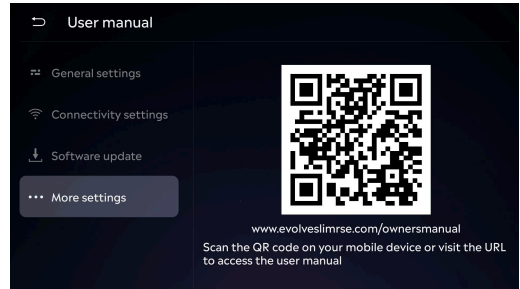

Restart

Selecting restart will allow you to shut down and restart the monitor. This could be used in case of a software glitch or a fresh start.

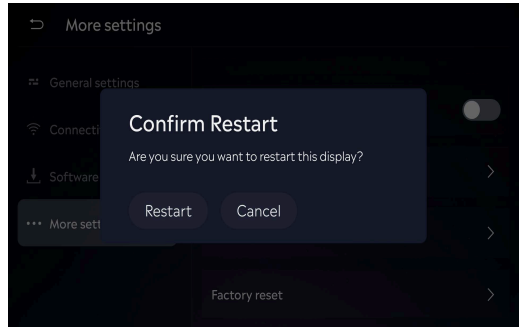

Factory Reset

A Factory reset will clear all your RSE settings and setup information to factory defaults. This will require you to complete the system setup again and all passwords and controls.

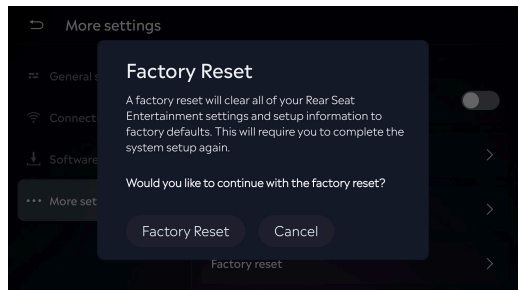

General Operating - Input Streaming

Streaming

Selecting "Streaming" will launch the ScreenHits app, where you can create a new account or sign-in to an existing account.

Once signed in to Screenhits, you can select the streaming services you subscribe to.



Using Screenhits Menu, discover new content. Use the TV Guide. Use Search to find a particular movie. Watch Live TV. Try your hand in the Gaming section.

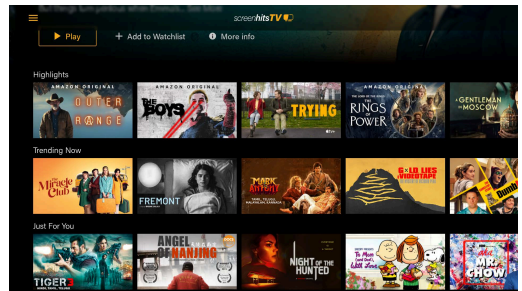
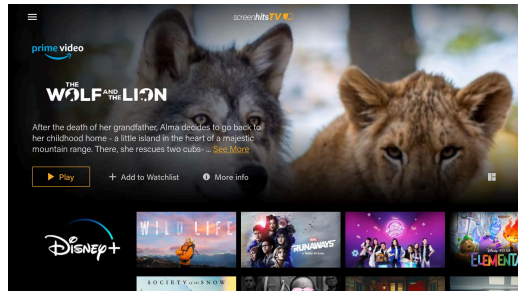

Subscribe or Sign into services like Disney+, Netflix, Kidoodle TV, Paramount+, Apple TV, and many others.

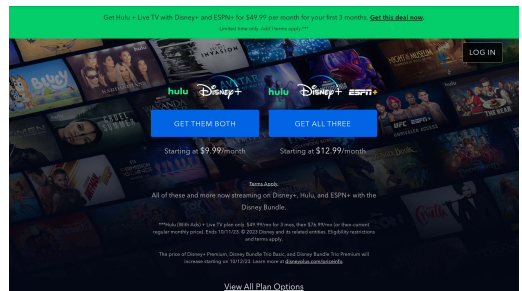

General Operating - Input Streaming

Gaming

Select gaming from the menu. Select many Gaming Favorites like Scorpion Solitaire, Brick Out, Minesweep, Roulette and many more.

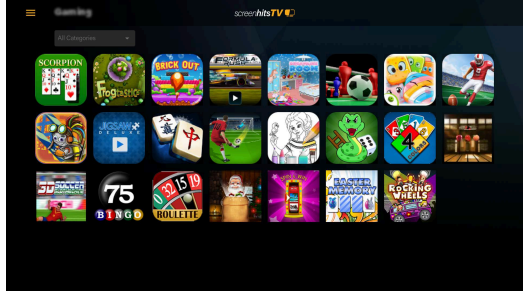

Live TV

Choose Live TV for current shows playing from many different TV broadcasts.

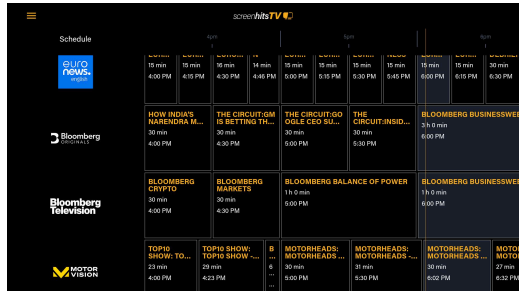

Profiles

choose setting from the menu and select "manage your profiles". You can remove and create new profiles. the profiles can be based on Male, Female, Kid, or Unspecified.

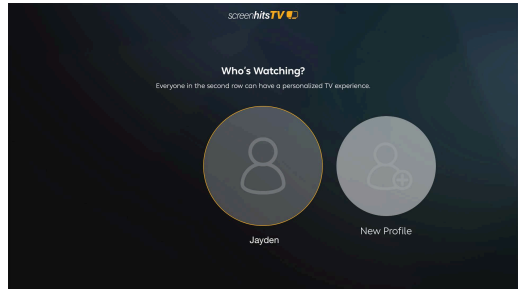

Parental Controls

Add a child protection pin to protect the child from using the system.



General Operating - Input Streaming

Streaming Search

Using the search bar in the menu, find content that is available within Screenhits and its services.

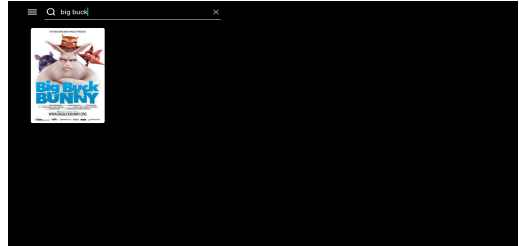
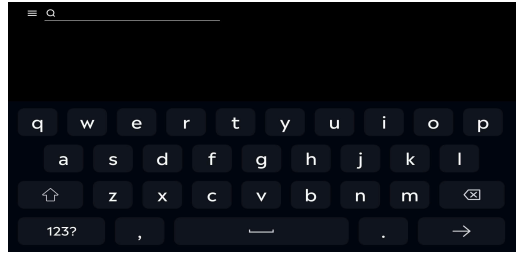

Services

Using Services in the menu find new subscriptions. Scroll through the different services and select. Follow the instructions and setup something exciting to watch.

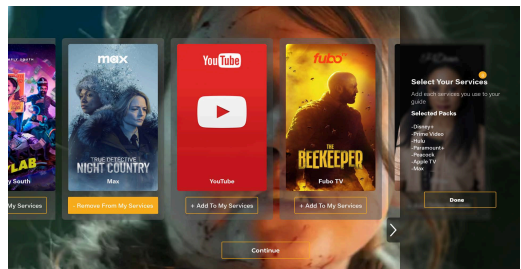
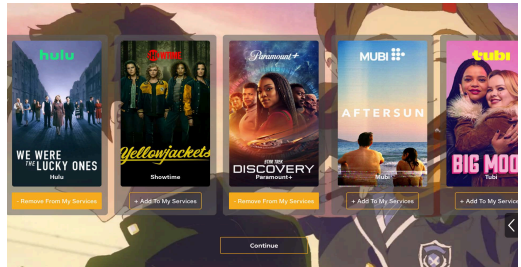

General Operating - Input USB

USB

Each display is equipped with a USB-C port which can be used to charge your device or to play non-Digital Rights Management content from a USB storage device. To Charge, connect your mobile device. To play USB media, connect your USB storage device and select "USB" to launch the media.

Continue to select the movie you are wanting to watch.

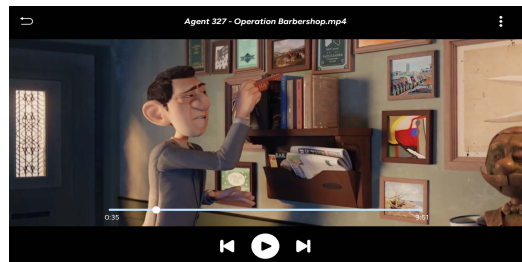
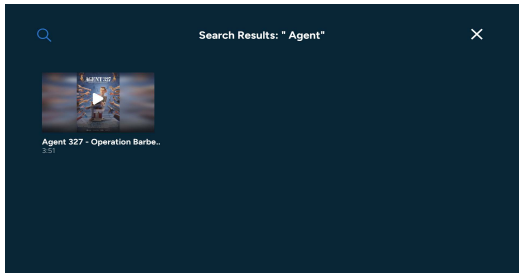
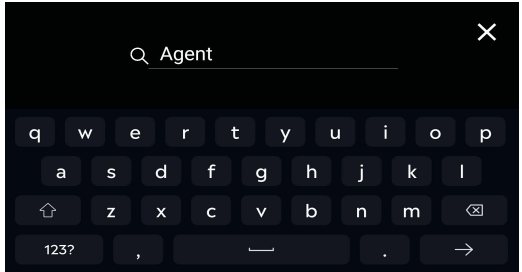
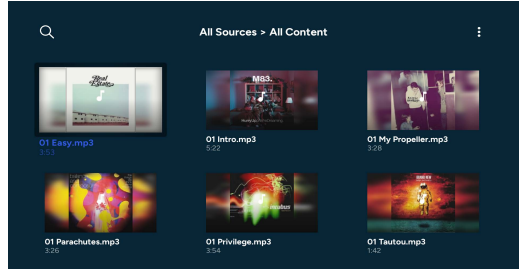

General Operating - Input USB

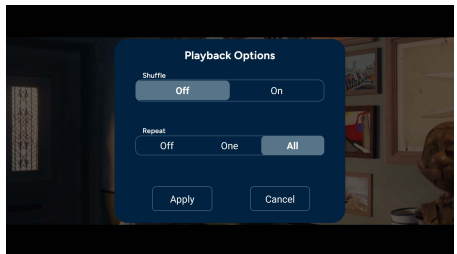
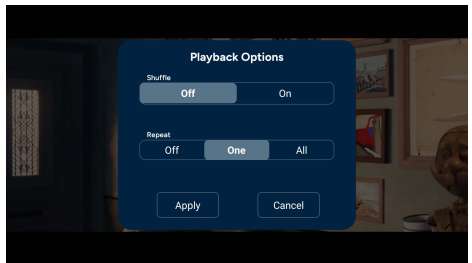
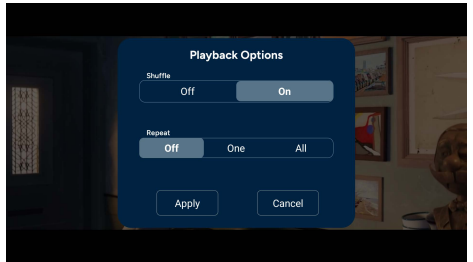
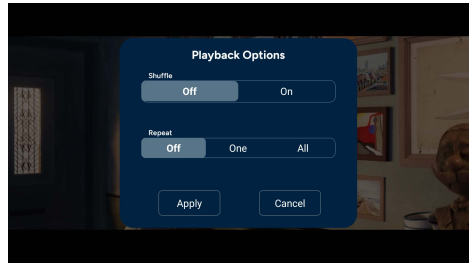

General Operating - Input HDMI

HDMI

Each display is equipped with a HDMI port which enables the connection of devices with HDMI output like laptops, tablets, gaming systems, etc...

Simply connect an HDMI cable between the device and select "HDMI" to watch.

Compliance Information

This device has been tested and found to comply with the limits for a Class B digital device, pursuant to part 15 of the FCC Rules. These limits are designed to provide reasonable protection against harmful interference in a residential installation. This device generates, uses, and can radiate radio frequency energy, and if not installed and used in accordance with the instructions, may cause harmful interference to radio communications. However, there is no guarantee that interference will not occur in a particular installation. If this device does cause unacceptable interference to radio or television reception, which can be determined by turning the device off and on, the user is encouraged to try to correct the interference by one or more of the following measures:

- Reorient or relocate the receiving antenna.
- Increase the separation between the device and receiver.
- Connect the device into an outlet on a circuit different from that to which the receiver is connected.
- Consult your dealer or an experienced radio/TV technician for help.

FCC Warning:

To assure continued FCC compliance, the user must use the provided grounded power supply cord and the shielded video interface cable with bonded ferrite cores. Also, any unauthorized change or modifications to this device would void the user's authority to operate this device.



ITE Notice:

This Class B digital apparatus complies with Canadian ICES-003.

Cet Appareil numérique de la classe B est conforme à la n^o arme NMB-003 du Canada.

This device complies with Industry Canada license-exempt RSS standard(s). Operation is subject to the following two conditions: (1) this device may not cause interference, and (2) this device must accept any interference, including interference that may cause undesired operation of the device.

Le présent appareil est conforme aux CNR d'Industrie Canada applicables aux appareils radio exempts de licence. L'exploitation est autorisée aux deux conditions suivantes : (1) l'appareil ne doit pas produire de rouillage, et (2) l'utilisateur de l'appareil doit accepter tout brouillage radioélectrique subi, même si le brouillage est susceptible d'en compromettre le fonctionnement.

Compliance Information

WEEE Notice

Disposal of Old Electrical & Electronic Equipment (Applicable in the European Union and other European countries with separate collection systems)



This symbol on the product or on its packaging indicates that device shall not be treated as household waste. Instead, it shall be handed over to the applicable collection point for the recycling of electrical and electronic equipment. By ensuring this device is disposed of correctly, you will help prevent potential negative consequences for the environment and human health, which could otherwise be caused by inappropriate waste handling of this device. The recycling of materials will help to conserve natural resources. For more detailed information about recycling of this device, please contact your local city office, your household waste disposal service, or the shop where you purchased the device. Applicable accessory: remote control.

Macrovision Notice

This product incorporates copyright protection technology that is protected by method claims of certain U.S. patents and other intellectual property rights owned by Macrovision Corporation and other rights owners. Use of this copyright protection technology must be authorized by Macrovision Corporation and is intended for home and other limited viewing uses only unless otherwise authorized by Macrovision Corporation. Reverse engineering or disassembly is prohibited.

The Bluetooth® word mark and logos are registered trademarks owned by Bluetooth SIG, Inc. And any use of such marks is under license. Other trademarks and trade names are those of their respective owners.



©2024 Voxx International Corporation.

The company, product and service names used in this quick start guide are for identification purposes only. All trademarks and registered trademarks are the property of their respective owners and are not affiliated with or sponsored by Voxx International Corporation or its affiliates.

The term HDMI® and the HDMI logo are trademarks or registered trademarks of HDMI Licensing LLC in the United States and other countries.